

mackworth
essentials

CT130 & CT200

CEILING TRACK HOIST



SPARE PARTS MANUAL

1. Contents

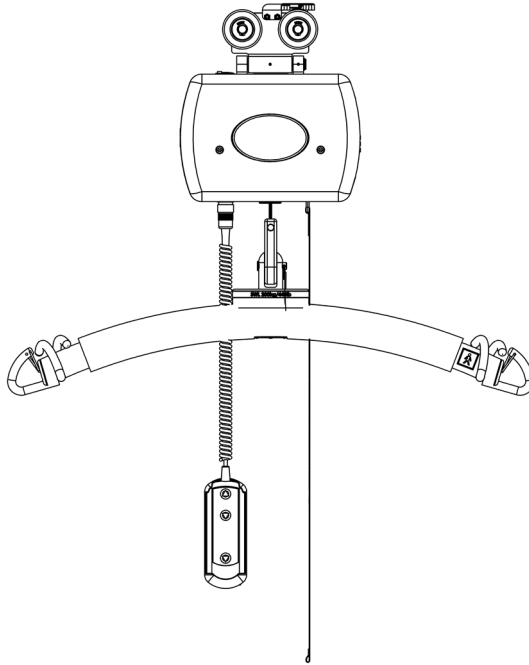

Description	Page(s)
Track Types	3
Spare Parts Summary	4-5
Part Code Detail	6-12
Notes	13-15
Contacts	16

2. Track Types

Track Type 1



Track Type 2

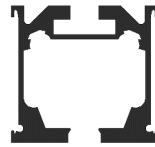

Track Type 3

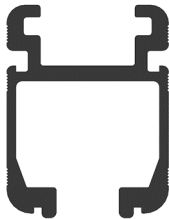

Track Type 4

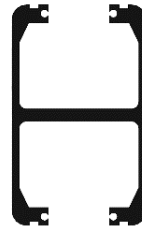

Track Type 5

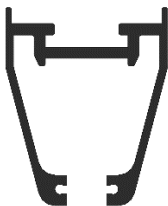



3. Spare Parts Summary

Part Code	Description
108911	CT130 PCB & Membrane
108912	CT200 PCB & Membrane
108143	Essentials Handset (Handset Charging)
108441	Essentials Handset (In Track Charging)
108442	CT Lift Motor A
108443	CT Lift Motor B
108001	CT Hub Assembly
108036	CT Limit Switch Assembly
108901	CT Battery Set (Pair)
108013	CT Strap Pin
108216	CT Emergency Lower Switch Assembly
108217	CT Emergency Lower Cord
300509	CT 130 kg Black Carry Bar Assembly
300508	CT 200 kg Black Carry Bar Assembly
300514	CT 130 kg White Carry Bar Assembly
300515	CT 200 kg White Carry Bar Assembly
440080	CT 130 kg Lift Tape Assembly
440085	CT 200 kg Lift Tape Assembly
108435	CT130 Front Cover Kit
108439	CT200 Front Cover Kit
108426	CT130 Rear Cover Kit
108425	CT200 Rear Cover Kit
108908	CT130/CT200 Top Cover Kit

Spare Parts Summary

Part Code	Description
108909	CT130/CT200 Bottom Cover Kit
430001	CT Lift Tape QRS Hook Assy
108226	CT Trolley (Track Type 1)
108227	CT Trolley (Track Type 2)
108228	CT Trolley (Track Type 3)
108228	CT Trolley (Track Type 4)
108229	CT Trolley (Track Type 5)
108302	CT Trolley (Type 1) (Track Charging)
108304	CT Trolley (Type 2) (Track Charging)
108303	CT Trolley (Type 3) (Track Charging)
108303	CT Trolley (Type 4) (Track Charging)
108306	CT Trolley (Type 5) (Track Charging)
104037	CT Wall Mounted Charger Kit
999008	Essentials CT User Manual

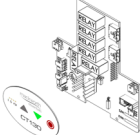
4. Part Code Detail

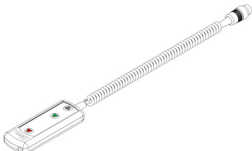
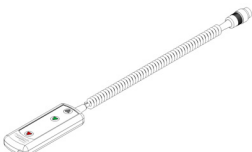
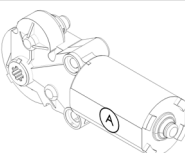
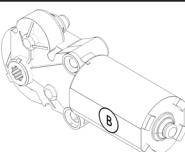
 <p>Diagram of the CT130 PCB and Membrane assembly, showing a printed circuit board with various components and a separate membrane with a green arrow pointing to a specific location.</p>	<p>CT130 PCB & Membrane 108911</p>
 <p>Diagram of the CT200 PCB and Membrane assembly, showing a printed circuit board with various components and a separate membrane with a green arrow pointing to a specific location.</p>	<p>CT200 PCB & Membrane 108912</p>
 <p>Diagram of the Essentials Handset (Handset Charging), showing a handset with a coiled cord and a charging base with a green arrow pointing to a specific location.</p>	<p>Essentials Handset (Handset Charging) 108143</p>
 <p>Diagram of the Essentials Handset (In Track Charging), showing a handset with a coiled cord and a charging base with a green arrow pointing to a specific location.</p>	<p>Essentials Handset (In Track Charging) 108441</p>
 <p>Diagram of the CT Lift Motor A, showing a cylindrical motor with a gear and a label 'A'.</p>	<p>CT Lift Motor A 108442</p>
 <p>Diagram of the CT Lift Motor B, showing a cylindrical motor with a gear and a label 'B'.</p>	<p>CT Lift Motor B 108443</p>



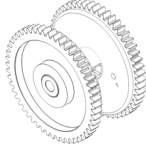
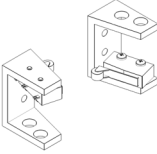
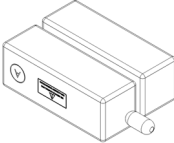
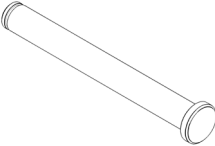
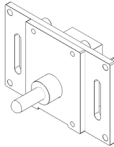
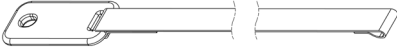

Part Code Detail

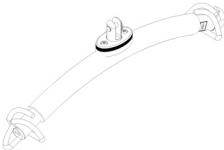
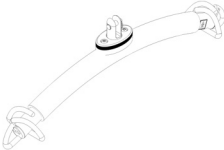
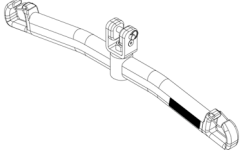
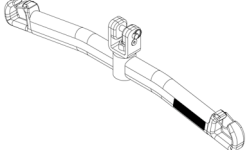
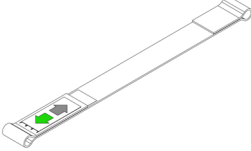
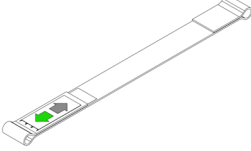
	<p>CT Hub Assembly 108001</p>
	<p>CT Limit Switch Assembly 108036</p>
	<p>CT Battery Set (Pair) 108901</p>
	<p>CT Strap Pin 108013</p>
	<p>CT Emergency Lower Switch Assembly 108216</p>
	<p>CT Emergency Lower Cord 108217</p>

Part Code Detail

	<p>CT 130 kg Black Carry Bar Assembly 300509</p>
	<p>CT 200 kg Black Carry Bar Assembly 300508</p>
	<p>CT 130 kg White Carry Bar Assembly 300514</p>
	<p>CT 200 kg White Carry Bar Assembly 300515</p>
	<p>CT 130 kg Lift Tape Assembly 440080</p>
	<p>CT 200 kg Lift Tape Assembly 440085</p>

Part Code Detail

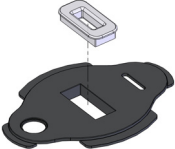
	<p>CT130 Front Cover Kit 108435</p>
	<p>CT200 Front Cover Kit 108439</p>
	<p>CT130 Rear Cover Kit 108426</p>
	<p>CT200 Rear Cover Kit 108425</p>
	<p>CT130/CT200 Top Cover Kit 108908</p>
	<p>CT130/CT200 Bottom Cover Kit 108909</p>

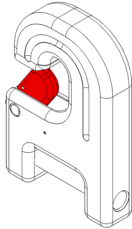
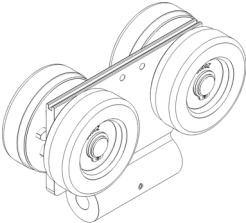
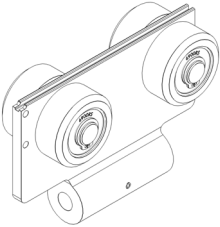
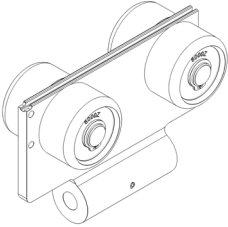

Part Code Detail

	<p>CT Lift Tape QRS Hook Assy 430001</p>
	<p>CT Trolley (Track Type 1) 108226</p>
	<p>CT Trolley (Track Type 2) 108227</p>
	<p>CT Trolley (Track Type 3) 108228</p>

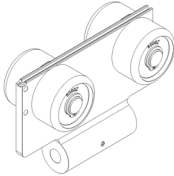
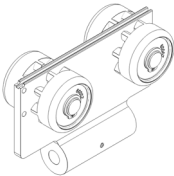
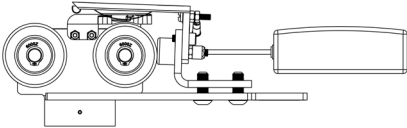
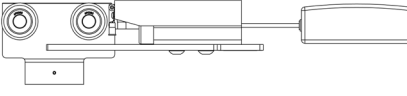
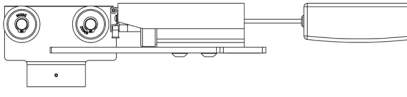
Part Code Detail

	<p>CT Trolley (Track Type 4) 108228</p>
	<p>CT Trolley (Track Type 5) 108229</p>
	<p>CT Trolley (Type 1) (Track Charging) 108302</p>
	<p>CT Trolley (Type 2) (Track Charging) 108304</p>
	<p>CT Trolley (Type 3) (Track Charging) 108303</p>

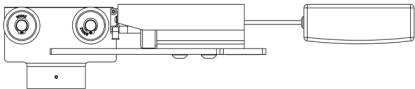
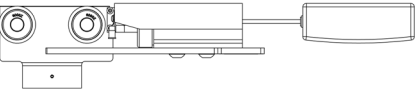
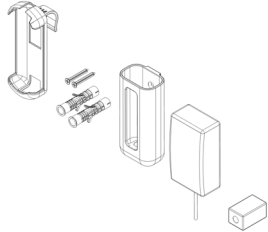
Part Code Detail

	<p>CT Trolley (Type 4) (Track Charging) 108303</p>
	<p>CT Trolley (Type 5) (Track Charging) 108306</p>
	<p>CT Wall Mounted Charger Kit 104037</p>
<div data-bbox="257 1141 397 1364" style="border: 1px solid black; padding: 5px; text-align: center;">  USER MANUAL </div>	<p>Essentials CT User Manual 999008</p>

5. Notes

Notes

Notes

6. Contacts

DEALER CONTACT DETAILS

MANUFACTURER CONTACT DETAILS

Unit 1, Tir Llwyd Industrial Estate, St Asaph Avenue, Kinmel Bay,
Conwy, United Kingdom, LL18 5JZ

Telephone: +44 (0)1924 840100
www.prismmedical.co.uk

DISCLAIMER

While every effort has been made to ensure the accuracy of information contained in this manual, no liability can be accepted by Prism Medical UK for any errors or omissions. Prism Medical UK operates a policy of continuous improvement. Specifications and other data are subject to change without notice.

prism**medicaluk**
a prism**healthcare** company

UK
CA



CE

